



## LG065X

The wax thermostatic element produced by the SMLG with its own patented formula is widely recognized, praised and applied in the industry for its sensitivity and accuracy. It has also passed the European experimental institutions product certification (ACS, WRAS)

### Technical Parameter

		Temperature(°C)	Stroke(mm)
Maximum Load	90N		
Minimum Load	15N	15°C~38°C	1.8±0.2
Testing Load	45N	35°C~38°C	0.6±0.05
Spring Rate	1N/mm	38°C~46°C	1.6±0.15
Maximum Temperature	90°C	38°C~60°C	2.4±0.25
Material	Copper	15°C~90°C	5.4Max

Stroke:L=18±0.25 mm at 38°C 45N

Lifespan:100000 times

### Application

- Automobile
- Plumbing
- Sanitary
- Shipping
- Air conditioning
- Military
- Other industries

### Customize Solution

If you are not sure about the parameters of thermostatic element, our team will assist you with your selection or customize according to your products' situation. Before any commitment, you need to send us written confirmation for the three performance parameters of the wax thermostatic element (temperature range, working stroke and maximum load).

### Dimension

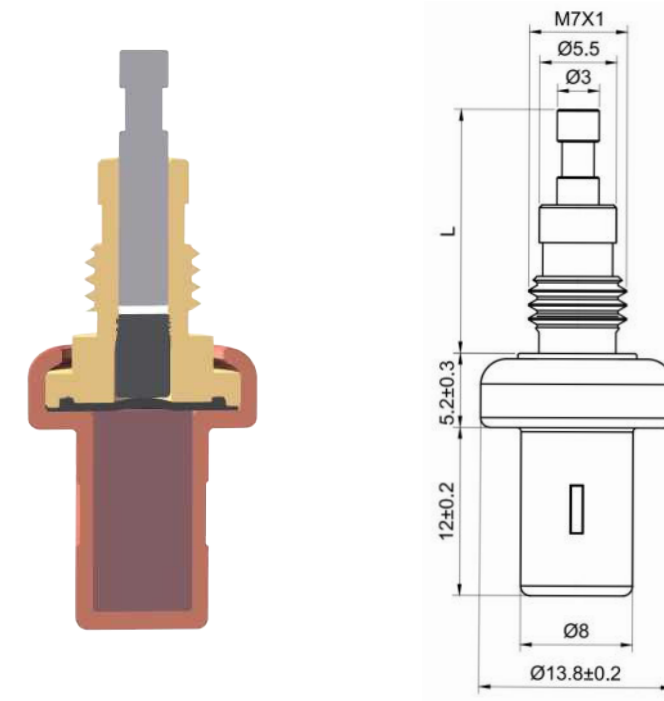

### Temperature VS. Stroke

