



LG052X

The wax thermostatic element produced by the SMLG with its own patented formula is widely recognized, praised and applied in the industry for its sensitivity and accuracy. It has also passed the European experimental institutions product certification (ACS, WRAS)

Technical Parameter

Maximum Load	140N	Temperature(°C)	Stroke(mm)
Minimum Load	45N	50°C ~ 55°C	0.3 ± 0.15
Testing Load	55N	55°C ~ 60°C	0.8 ± 0.15
Spring Rate	5N/mm	60°C ~ 65°C	1.55 ± 0.15
Maximum Temperature	90°C	65°C ~ 70°C	0.8 ± 0.15
Material	Copper		
Stroke:L=19±0.3mm at 55°C 55N			
Lifespan:100000 times			

Application

- Automobile
- Shipping
- other industries
- Plumbing
- Air conditioning
- Sanitary
- Military

Customize Solution

If you are not sure about the parameters of thermostatic element, our team will assist you with your selection or customize according to your products' situation. Before any commitment, you need to send us written confirmation for the three performance parameters of the wax thermostatic element (temperature range, working stroke and maximum load).

Dimension

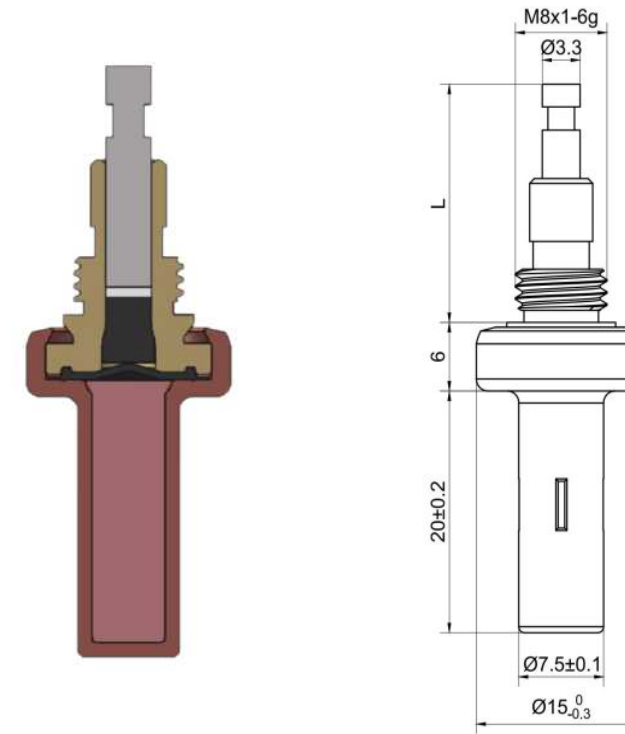

Temperature VS. Stroke

